

Positive Energy in Interior Design and Furniture	:العنوان
مجلة التصميم الدولية	:المصدر
الجمعية العلمية للمصممين	:الناشر
Attia, Doaa Ismail Ismail	:المؤلف الرئيسي
مج2, ع2	:المجلد/العدد
نعم	:محكمة
2012	:التاريخ الميلادي
أكتوبر	:الشهر
5 - 23	:الصفحات
1021408	:رقم MD
بحوث ومقالات	:نوع المحتوى
English	:اللغة
HumanIndex	:قواعد المعلومات
الفنون التطبيقية، التصميم الداخلي، تصميم الأثاث	:مواضيع
http://search.mandumah.com/Record/1021408	:رابط

Positive Energy in Interior Design and Furniture

By Dr. Doaa ismail ismail attia

Lecturer of interior design & furniture

Faculty of applied arts , Mansoura university

Abstract:

With the advancement of recent technology, we are subjected to various types of harmful unseen rays and waves which pollute our surrounding environment and is considered a danger that may destroy our immune system . Since the human being spends a large part of his life in the interior space this means that the interior design and furniture don't only produce relaxing furniture, suitable light ,harmony in colors and beautiful design ,but also, must play an important role in protecting the user of the space from the harmful effects of the recent technology . This could be achieved by using the aspect of energy in interior design and furniture and occurs as a result of the linguistic definition for energy: "the capability of doing effect". It is enough to study its effects reflected on the space user . Positive *Arranging energy* produced from the different elements of design:(shape, texture, color, material and light) with *specific characteristics* balance the harmful electric and electromagnetic fields which surround the human being in interior spaces. Hence, it changes the effective relationship between these fields and the user of the interior space which leads to changes in the user's feeling into being more vital and more able to reproduce.

In the present work, we paid attention to the shape as an element of design, by considering some well-known biogeometrical shapes(1) used as tools to produce positive arranging energy .Also, we tried to introduce with analysis, new geometric shapes satisfying the golden ratio and hence producing positive *arranging energy*. These shapes can be used in design and furniture to give relaxing and healthy place.

Keywords:

Bio-geometry, Positive Energy, interior design

3. Introduction:

We shape our homes and then our homes shape us, which is due to spending a large part of our life indoors. In this era of unprecedented technological advancement ,it stands to reason that we would use our knowledge to create indoor environment with exceptional vitality, which would enhance health and sense of well-being . According to this ,it is very important to add a new meaning to the interior design and furniture, which reflects health on the user of the place .This could be achieved through insisting on the role of positive energy using *specific characteristics* for design elements (shape ,color , texture ,material and light) whether this positive energy is *beauty energy* that imposes happiness, relaxation and vitality ,or *arranging energy* which balance the effect of negative energy existing in the interior

space like the harmful electric and electromagnetic waves, or *biological energy* which removes the effect of atmospheric pollution as a result of poisonous chemical gases . All these different types of energies work together to achieve balance, harmony and unity in designing and furnishing interior space thus reflecting positivity on the space user.

The methodology included in this paper helps the interior designer to enhance the role of positive energy when designing and furnishing living spaces to achieve harmony between the human body as an energy field and the energy of space and place. This methodology is based on designing furniture with *specific characteristics* and is strategically placed in space to neutralize negative energy and add a positive quality to it.

The paper is divided into five sections: the first explains the concept of design and furniture with

energy. The second section gives the relationship between biogeometrical shapes and arranging energy, and includes some well known biogeometrical shapes⁽¹⁾. It introduces also analysis for new geometrical golden shapes, where all these shapes emit *arranging energy* which reduces the negative effects of the harmful electromagnetic waves on our biological system. The third section, includes the analysis for some Islamic interior architecture, as well as analysis for some Islamic and recent furniture's, where all emit the *arranging energy* in the space. The fourth section, includes ways of upgrading the effect of positive energy in interior design and furniture. The last section, is an application example for designing and furnishing interior space in a coastal environment using positive energy.

First: The concept of design with energy:

Definition of energy:

The Encyclopedia "Britannica" defined energy as "*the capability of doing action or effect*". This means that energy is defined by its characters or appearance, and it is considered positive if these characters are good and vice versa. According to that, everything has an energy which appears in the different effects produced by it. For example, a person has *positive energy* simply if he has good characters such as being joyful, optimistic, generous, calm, ...etc, while he has negative energy if he has bad characters. Increasing the positive energy for a person leads to improving his balance, vitality and accepting life. Thus, positive energy is one of the principles for good life.⁽²⁾

Positive energy in interior design and furniture:

The positive energy in interior design and furniture is the positive effect that appears in interior space and affects the space user as a result of using design elements with *specific characteristics*. We divide positive energy in interior design and furniture into three categories:

1- *Beauty energy* which is based on using the artistic characteristics of design elements to achieve beauty⁽³⁾

2- *Arranging energy* which is based on using design elements with specific geometrical characteristics to emit positive energy to balance the harmful negative electromagnetic energy.⁽¹⁾

3- *Biological energy* which is based on using varieties of plants that have great ability than others to remove harmful air pollution in interior spaces. An example of these plants is the "peace lily" which removes the effect of benzene, xylene and toluene found in paints, solvents and adhesives. Also, the "figus" removes the formaldehyde used in some kinds of dyeing material of furniture and wall paper. Another example is the wheat herbs, since placing them beside electric devices had proven that it reduces the harmful emissions of electromagnetic fields in the interior spaces⁽⁴⁾

Natural and non- natural energy in interior design and furniture:

Natural energy in interior design and furniture is a positive energy generated from using natural design elements with good characteristics, and under suitable circumstances it performs the role God created it for. For example, different natural colors have distinct characteristics. The red color is characterized by increasing the physical activity which acts as a positive characteristic if used in nursery and sports places. Hence, the red color satisfies harmony, balance and unity with the place and reflects positive energy on the space user by enhancing the feeling of the beauty, the ideal performance, and physiological and psychological health. Yet, it produces its negative characteristics if it is used in reading or sleeping rooms, or homes for old people, because these places need calmness and concentration. These characteristics are not available in the red color, but exists in the blue color thus satisfying balance, harmony and unity with the place and reflects this positively on the place user.

As regards the texture, for example the natural smooth shining texture gives the feeling of wideless space and hence coldness. These are considered negative characteristics if this type of texture is used in homes for old people, because it induces blurring of vision and depression among the inhabitants. Yet, it is considered as a positive characteristic if it is used in swimming pools

,kitchens ,and narrow places, as it reflects positively on the user of the place . These aspects can be applied on the rest of the natural design elements, under suitable circumstances gives positive energy and so positive effects on the place user.

The non-natural energy is the one generated in case of using non-natural (artificial) design elements where under suitable circumstance it has at the same time both positive and negative energy . It has positive energy when it achieve the suitable design character and hence reflects positively on the user of the space. Also, because it is a man factorization , it has negative environmental effect which harm the user of the space.

Second :Energy and the shape element in interior design and furniture:

Everything in nature has a shape and every shape contains energy, so every thing in nature has energy. Energy exists in the fields surrounding the shapes.

A-Positive arranging energy and Biogeometrical shapes :

Shapes produce vibration waves that affect the surrounding area . If this effect arrange the balance of energy in the space then it is a positive *arranging energy* ,and if this effect disturbs the balance of energy then it is a negative energy .

Biogeometrical shapes BG3:

The Biogeometrical shapes are the only shapes which produce energy fields in the surrounding area with the following three components(4):

- The first component, which Chaumery and de Belizal named negative green, is an energy emittor because it produces that kind of vibrations with continuous movement which acts as a carrier and penetrating –wave .It has two components (fig1)(4):a useful horizontal negative green and a harmful vertical negative green which occurs only with continuous exposure. Thus, it is very important to remove the harmful effect of energy for vertical negative green waves and keep the horizontal negative green waves .For example ,in pyramidal shapes ,this is applied by using very small inclination less than half degree in the middle of every face of the pyramid ,very little

indentation in the sides of the pyramid . This is the way ancient egyptians used while building the large pyramid (fig2)(4).Also, the vertical negative green waves appear in the hemisphere or the dome shapes. (fig3)(4) It is balanced or cancelled by either :a little increase or decrease in the height of the hemisphere so it becomes no more a hemisphere; changing the shape of dome to be pointed from the top ;putting the dome on a neck ; putting on top of it the shape of crescent ;putting something emergeing on the top, and these are the ways the moslems used in their mosques .These particular shapes are energy emitters for a type of penetrating carrier wave(fig4)(4). Vaults with hemispherical or dome-like sections produce both aspects of negative green waves.The corrections applied for hemispheres and domes are also applied for the hemisphere or the dome section.

The harmful energy produced by the vertical negative green waves in the electrical and electromagnatic fields in interior spaces is due to the usage of modern appliances ,electric wiring, artificial materials , building substances , finishing materials and furniture layout and so on . When designing and furnishing interior space ,it is very important to choose shapes with *specific characteristics* ,which has the effect of emitting *arranging energy* around it , and thus removing the harmful effect of the negative energy in interior space.

-The second component is a higher harmonic of ultra- violet which balances overactive organ functions and has a calming effect on the nervous system.

-The third component is a higher harmonic of gold .It has energizing effect that balances the body's immune system.(6)

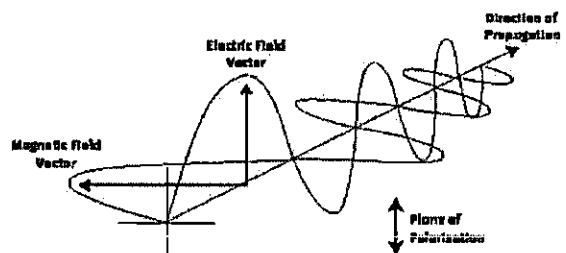

(fig1) vertical & horizontal negative green (4)

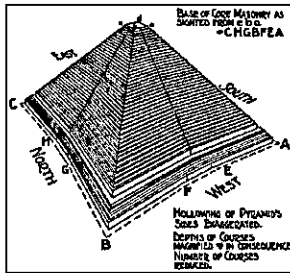

(fig 2)
:inclination in the middle of every face of the pyramid which stop the energy harmful effect

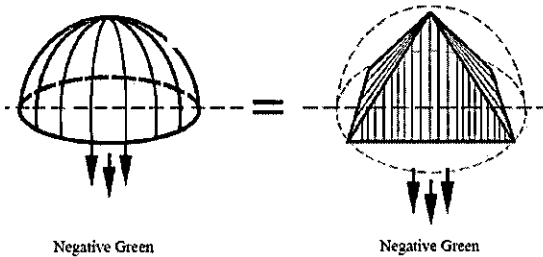
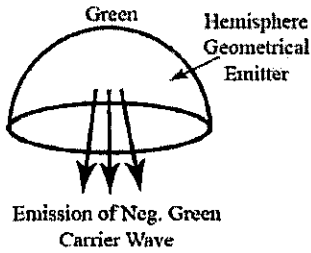

(fig 3) Geometric subtle energy (4)

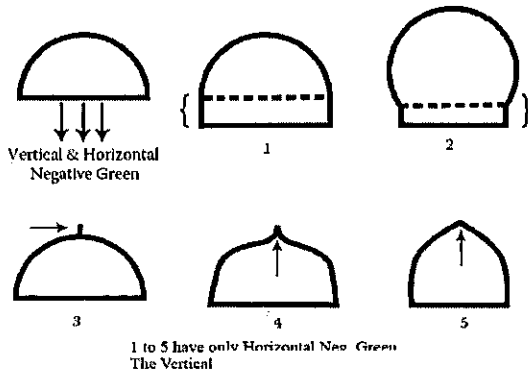

(Fig 4) shows the different ways to treat the energy problems in case of hemispheric dome (4)

B- Some Biogeometrical shapes (tools) used as arranging energy emitters

In what follows, we introduce some geometrical shapes which the interior designers can use it in

design and furniture to induce balance to the space.

- 45 degrees shape:

Consists of a straight line and two other lines forming 45 degrees at the two ends of the straight line .This is an *arranging energy* emitter between the two lines in the horizontal position(fig5) . (1)

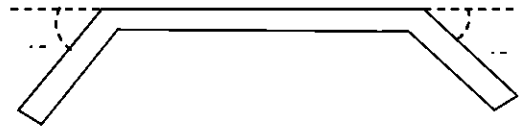

(fig 5) the 45 degrees geometric shape.(1)

- The right angle shape (gate or dolman – like shape);

This shape belongs historically to the old ages ,where a big stone is placed over two vertical stones giving the shape of a gate. If it is directed towards the east or the west ,positive arranging energy will be emitted from it for distances, thus, it improves the place energy (fig6)(4)

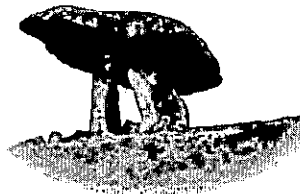

(fig7) shows one side the Corner sta shapes(5)

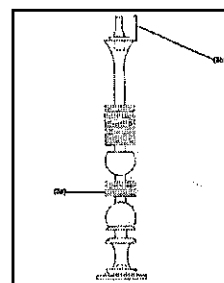

(fig6) shows the dolman shape (4)

- Corner stands:

It possesses the geometrical shape (fig7) ,which produces *arranging energy* around it and extends about 50-70cm .When the stand is placed in the corner of a room standing upright, the deflection of energy that occurs there, will spread the energy-balancing qualities in the entire room .

- L-Biogeometrical shapes:

Around L-shapes in (Fig 8a&b) exists a field of *arranging energy* which balances the electromagnetic energy produced by the electrical appliances present at home, as well as some wall polishes , ..etc. (5)

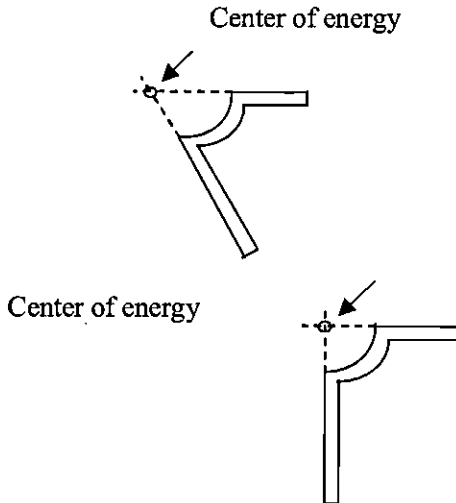

(fig8 a,b) L-1 metrical shapes(5)

- The biogeometric carpet:

It is designed using the biogeometrical shapes to produce energy balance into the space above it.(fig9) (9) It is most beneficial when placed under the bed ,to provide balancing of energy during the sleeping hours.

- The copper spiral pair:

It is a pair of copper spirals placed inside each other such that one turn clockwise and the other turn anticlockwise .It is placed on higher places, such as the ceiling to collect the negative energy existing in the interior space (fig10) (9).

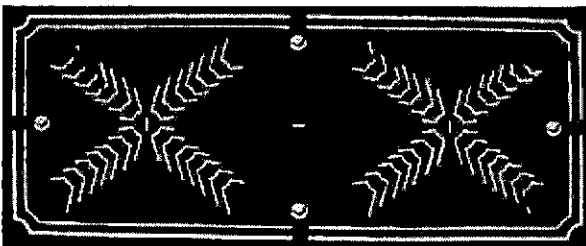

(fig9) biogeometric carpet (9)

- Geometrical shapes with centers:

The center of any geometric shape (circle , square,..) produces balancing energy which is emitted in the surrounding space . (4)

- Symmetrical geometric shapes and its movements :

The process of the overlapping (fig10) the copper symmetrical geometric shape either by rotation, shifting , double interface, or repetition create *arranging energy*.(4)

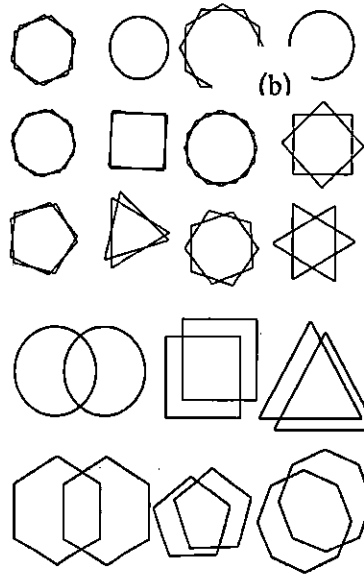

(Fig12) creating arranging energy through shifting of shapes. (4)

(Fig 11) creating arranging energy through Rotation of shapes around the center. (4)

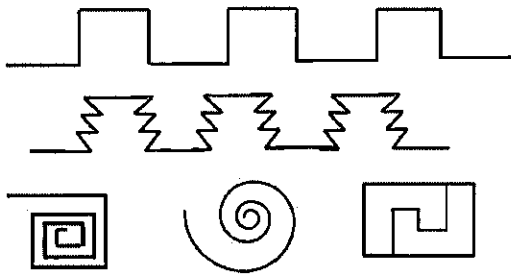

(fig13) Creating arranging energy through double interface and repetitions of shapes.(4)

• **Biosignature shapes;**

These are Biogeometric shapes for different organs of the human body. If we put these shapes in the disturbed field of energy of sick organ , for long enough time, it can correct it to its ideal energy signatures , thus performing its normal function . (fig14)(1)

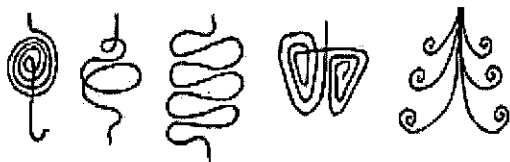

Liver stomach intestine heart lung

(fig14) some biosignatures shapes(1)

C- Some geometrical golden shapes are arranging energy emitters;

As regards the previously mentioned biogeometrical shapes ,it hasn' t been explained how did they discover these shapes or analyse it as a source of *arranging energy* in any of the biogeometrical references but the authors in these references confirmed the presence of this *arranging energy* by measuring it' s existence using specific instruments.(10,9,4,1)

In what follows, we will introduce with analysis new golden geometric spiral shapes producing positive arranging energy. The numbers of Fibonacci series 1,1,2,3,5,8,13, 21 ,..., Gava series 1,1,2,2,3,4,5,7,9,12,16,21,.. and the golden ratio $\phi = 1,618$, affects the emission of arranging energy to balance the space(4).Some of the geometrical shapes based on them are :

golden rectangle ,the golden triangle ,and the golden spiral. They are known geometrically as shapes based on ϕ with infinite number of ϕ triangles with dimensions $(\phi,1),(1,1/\phi),(1/\phi,1/\phi^2),(1/\phi^2,1/\phi^3),...$ producing geometrical movements: repetition ,shifting, interfacing and rotation,and according to biogeometry principles(4) ,they create *arranging energy* and hence introduce balance to space.

In what follows we give geometrical analysis for 90,36 and 45 degrees shapes produced ,respectively, from the golden rectangle ,triangle and spiral shaped and considered as arranging energy emitter.

The 90 degrees L-shape :

(fig 15), the geometric shape (abdh) consists of the two perpendicular lines ab&dh where $ab:dh=1:(1/\phi^2) = \phi^2$ joined by the quarter circumference of a circle with center c and radius of length $1/\phi$.This geometric shape joins the three successive squares with the lengths ; $1,1/\phi,1/\phi^2$.

Also ,the shape (cdwm)joining the four squares of lengths $1, 1/\phi, 1/\phi^2, 1/\phi^3$ where $cd:wm=(1/\phi):(1+1/\phi^3)=1/2$ and the curve dw is the quarter circumference of a circle of center h and radius of length $1/\phi^2$.

The 36 degrees L- shape:

In (fig16),the shape (abdh) consists of the two lines ab and dh having an angle of intersection= 36° $ab :dh=1:(1/\phi^2)= \phi^2$, joined by a curve which is a part of the circumference of the circle with centre c and radius of length $1/\phi$ and also is a part of the golden spiral which passes through the successive golden triangles $A_{mc}, c_{bm}, b_{cd}, ...$ etc. The geometric shape(abdh) joins three successive triangles with base length $1,1/\phi,1/\phi^2$.

Both the 90 degrees L-shape and the 36 degrees L-shape manage the problem of the pointing corner by transforming the harmful energy effect in front of a corner into a balancing effect.(4)

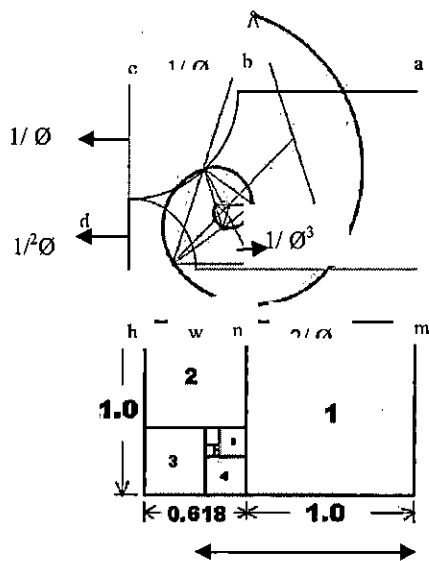

(fig15)golden rectangle

The golden spiral in nature:

The golden spiral is a horizontal or vertical geometric spiral shape satisfying the golden ratio .It appears in nature in the structural growth for plants ,animals and human beings. For example, two series of horizontal clockwise and anticlockwise golden spiral curves with two successive numbers in Fibonacci series (fig17)(3) fill the space of half the flower with the best filling angle 137.5 degree. Also ,the vertical golden spiral appears in plants with the leaves and branches, where we find that the leaf directly above the leaf number zero and has the same direction, has the number 8, and every leaf has the angle 137,5 degrees from the previous one ,and thus the leaves take the shape of the vertical golden spiral upto the top around the stem with number (5,3) clockwise and anticlockwise ,respectively. The numbers (8,5,3) are successive numbers in Fibonacci series(fig18) (3). According to that , plants emit the natural *beauty* and *arranging energy* in the space surrounding it , hence reflect relaxation , psychological calmness ,and body balance.

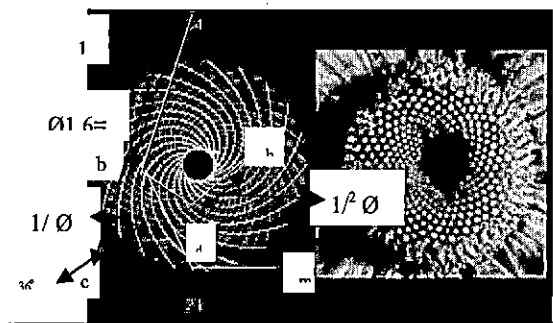

(fig17) head of the flower consist of two clock and anticlockwise golden sniral series.(3)

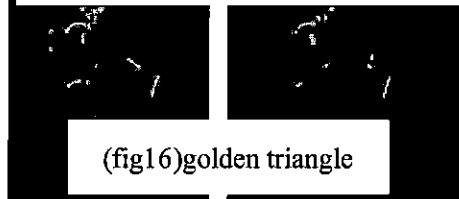

(fig16)golden triangle

(fig 18) clarif plant lea

The 45 degrees-shapes:

In what follows, we will discuss new geometrical shapes which are considered as *arranging energy* emitters resulting from the horizontal golden spiral .These shapes can be used horizontally in interior design and furniture. These shapes are based on two straight lines forming 45degrees at the two end points of a third fixed straight line .There is a golden ratio relationship between the length of the three joined lines.

- In (Fig 19) the shape (abcd), where $ab:bc:cd=(\sqrt{2}/\phi):\phi:\sqrt{2}$ is based on the three tangents at the points A,B,C on the golden spiral lies in the two successive squares in the golden rectangle with side ratio $1:1/\phi$. We can choose $ab \leq \sqrt{2}k/\phi$, $cd \leq \sqrt{2}k$,but bc is fixed $=k\phi$ where k is a constant > 0 .

-Also the shape(nabc) where $na:ab:bc=1:\sqrt{2}/\phi:\phi$, is based on the three tangents at the points N,A,B on the golden spiral and joins the three successive squares in the golden rectangle with length ratio $1:1/\phi:1/\phi^2$

note: we consider (fig5) as a special case of the above golden spiral geometric shapes.

- The five sides geometric shape (bcdefw) results from the two golden symmetrical spirals facing each other, where $cd = ef = \sqrt{2}k$ & $fw = bc = k \phi$ $de = 2k$. The two equal lines bc & fw have the relation $k < bc = fw \leq k \phi$, which means that we can decrease the length of the two free sides with condition that the shape must be in at least the four successive squares.

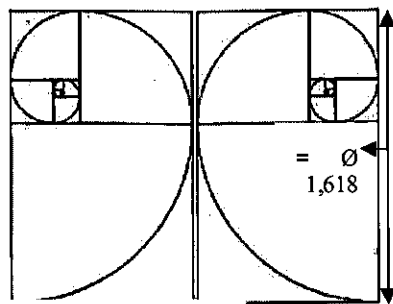

(fig20)

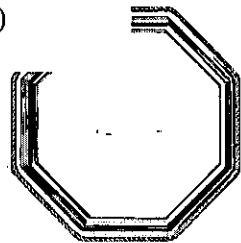

Octagon:

The octagon emits arranging energy, because it has a center, and the number 8 of its sides is a Fibonacci number and it is a 45 degrees -shape. (fig20)

Gava spiral:

It is based on the repetition of the Gava triangles with side length of Gava series 1,1,2,2,3,4,5,7,9,12,16,21,28,... .These triangles create a rotation and repetition, and double interface geometric movements. According to the biogeometrical principles, Gava spiral creates a *balancing energy* in the area surrounding the center (fig21)

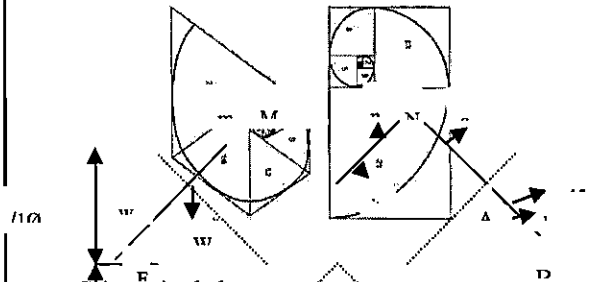

Biological shapes:

In interior design and furniture, the designer takes inspiration from living creatures in nature. Biological shapes and principles, rules and orders are abstracted into geometric shapes. Hence, the designer's work bears natural characteristics, whether in shape or content and thus, it bears natural *beauty* and *arranging energy*, hence inducing balance, harmony and unity to the place.

Third :Analysis of some Islamic interior architecture elements ,furniture and some recent furnitures which are arranging energy emitters

A- Elements in Islamic interior architecture.

These (fig19) analysis of geometrical ratio geomet shapes from horizontal golden arranging energy spiral with best ratio.

• ARCH:

It is used in Islamic houses as a passing opening, whether hollow or prominent on the wall, for design requirements like wooden arch for a furniture unit, binding on the wall, or surrounding the Mashrabiya opening. The arch has different types of well known hemisphere or dome shapes e.g.:two centers arch (fig 22a),circular pointed arch (fig 22b), Horse Shoe arch (fig22c),Onion – shaped arch, and Fatimy arch (keel arch)(fig22d)(8)

(fig. and C Fib

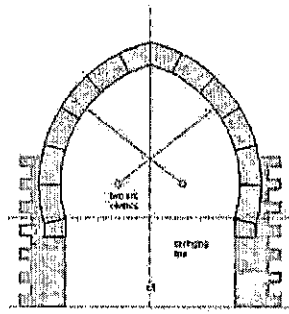

(fig22a) two center arch

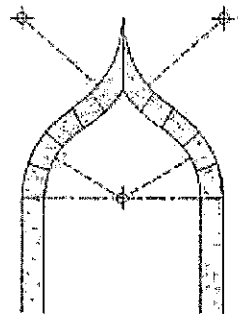
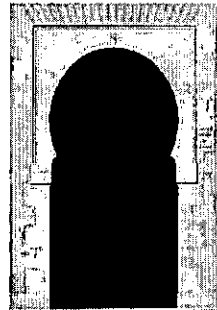
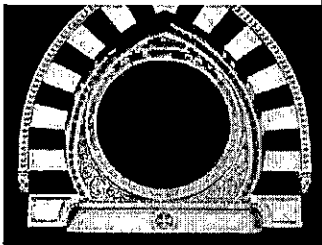

(fig22b) circular pointed arch.(14)

• El-kart:

Repeated , double interface geometrical shape units with centers, like sphere ,cube , oval ,...etc, (fig23).It is used to cover Islamic openings.

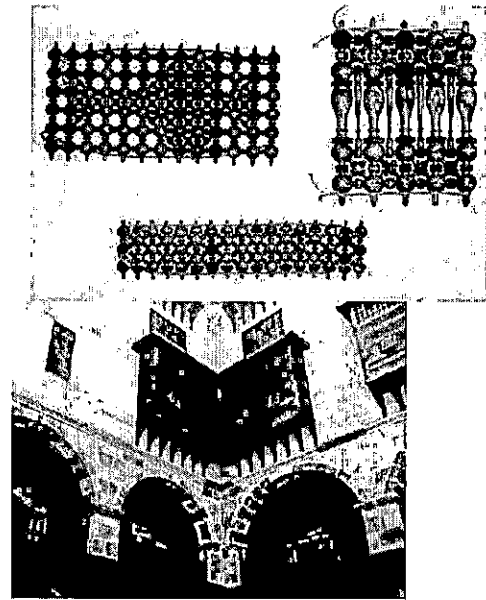

(fig24)(15)
(fig23)(15)

• El-Kaboly:

It is an Islamic element made of wood or stone(8) and bears above it things like Mashrabiya ,...etc. Choosing any geometric golden shape as the plane for kaboly (fig15,16,19), to emit arranging energy. (fig25)

• Masharabiya:

(fig22c) Horse Shoe arch(14) (fig 22d)Fatimy arch (keel arch) interior privacy ; from inside(fig.24). It is decorated with Elkart (fig 26). The planes of Mashrabiya and its kabolies are chosen to be geometric golden shapes (fig 15,16,19), to be an arranging energy emitter.

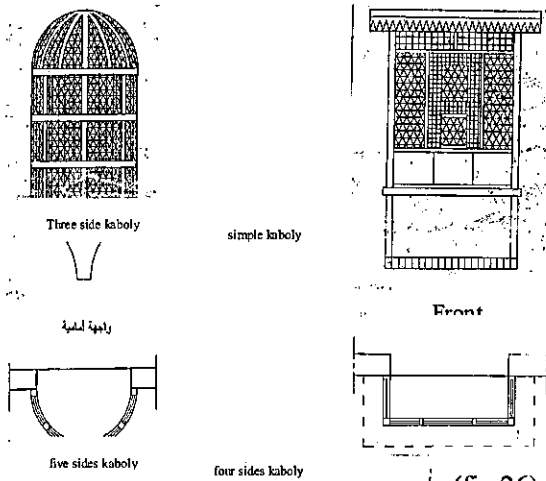

(fig 26) planes for different types of Masharabiya.

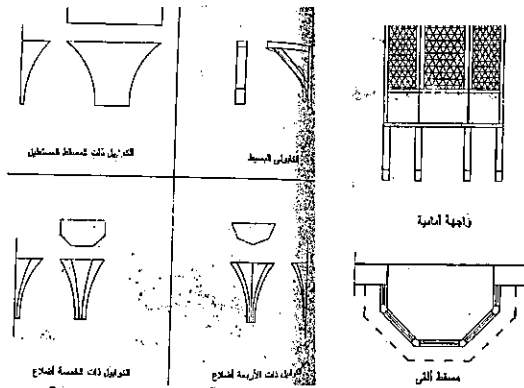

(fig25) different types of kaboly. ; 26)

• Crenellations:

It consists of repeated geometric shapes units with double interface and shifting .These are used as upper extremity of the building where they create arranging energy and distribute it inside(fig13) . We may choose biogeometric shapes(arch)or golden geometric shapes (vertical spiral)for these units to increase positive energy.

B- Furnitures:

Islamic furnitures

Fig27:

the lower part of an Islamic style console it's consists of 45 degrees horizontal shape born on a 90 degrees L-shaped kaboly . The upper part is a mirror, its shape is a combination of pointed

circular arch and two equal squares, with a common center, and geometric rotation and repeated movements.

Fig 28:

A chair, its back and seat designed as a 45 degrees golden geometric shape . The back and the seat of the chair are inlayed with rotating ,double interfacing and repeated squares with a common center the top of their exists a decoration of dome shape.

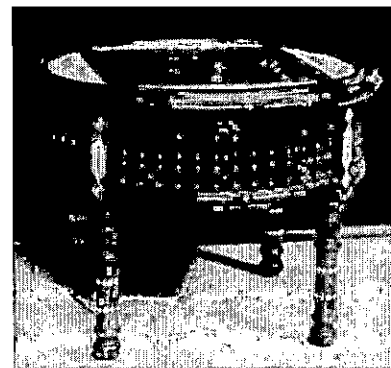
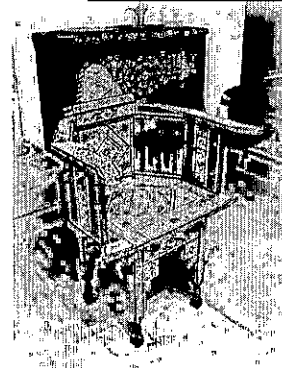
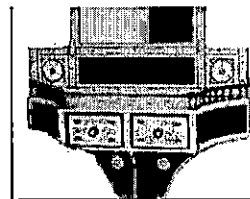

(13)

(fig29) (13)

(fig27) (13)

(fig28)

Fig 29:

A circular table , its sides are decorated with Islamic kart.

Fig 30a,b:

Two different Islamic -shaped tables ,chairs and a sofa based on 45 degrees shape with Islamic arch-shape for decorating the legs.

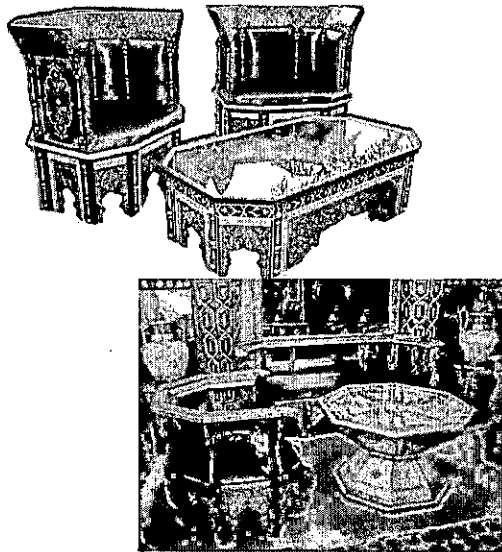

(fig30b)

(13)

(fig30a) (13)

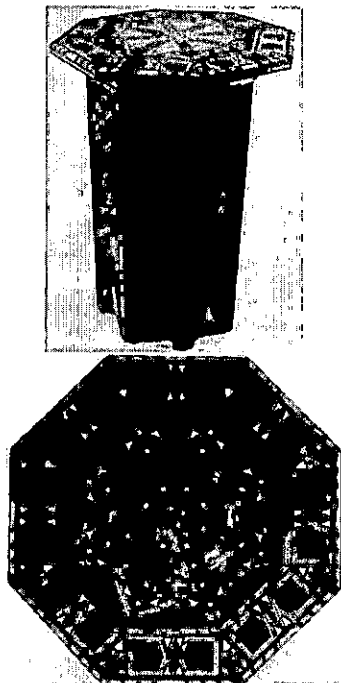

(fig31) (13)

Fig31: Octagonal Islamic table ,its pinch is inlaid with geometrical movements of squares ,arches ,circles , octagonals ,triangles , rectangles.

Recent Furnitures

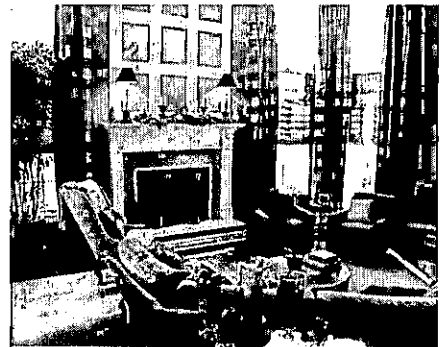

(fig33)(11)

(fig32)(11)

Fig32:

The sofa in the living room is based on a 45 - degrees shape . The fireplace has the dolmen shape , with three dome- shaped as cover sections . The wall above is decorated with interfaced , repeated squares .The two chairs in the corner are symmetrically balanced. The table has a circular shape. Natural energy is emitted in the room by the shade plant, and also by using natural wood and cotton in furniture and floor.

Fig33:

It shows the interior of a house where the stair has the golden vertical spiral shape. The design of the chandelier depends on the golden spirals shapes, with its size proportional to the vastness of the space. The floor is decorated by octagon geometric shape. As regards the design of the two bankiets :one has a golden rectangle shape, the other has a golden spiral shape. Natural energy is emitted from using: copper and crystals used for the chandelier, also natural wood for furniture, and natural marble with granite bands for flooring.

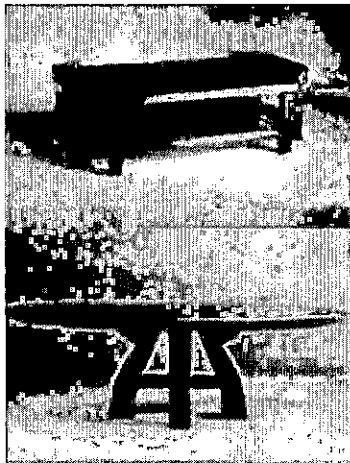

(fig34b)

(fig34c)
(fig34a)

- (Fig34.a,b,c):

Three different tables designs: the first has a circular shape with 90 degrees L-shaped legs, the second has a rectangular shape, with corners managed by 90 degrees L -shape, and the third has the dolman shape.

Some of Gaudi's work in design and furniture:

Gaudi's work in design and furniture emits *natural beauty* and *arranging* energies by divestituring the biological shapes with its principles, rules and orders to geometric shapes.

- Gaudi's serpentine seat for the uncovered theatre in Guell park.

It is formed as a series of equally repeated, interface, successive, opposite semicircles united in their centers line which form a circumference of a circle bounded the theatre (fig35 a,b,c). According to biogeometry principles, the seat create beauty and balancing energy.

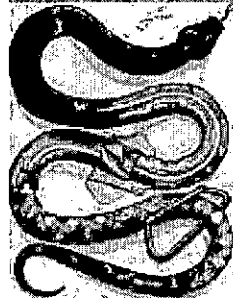
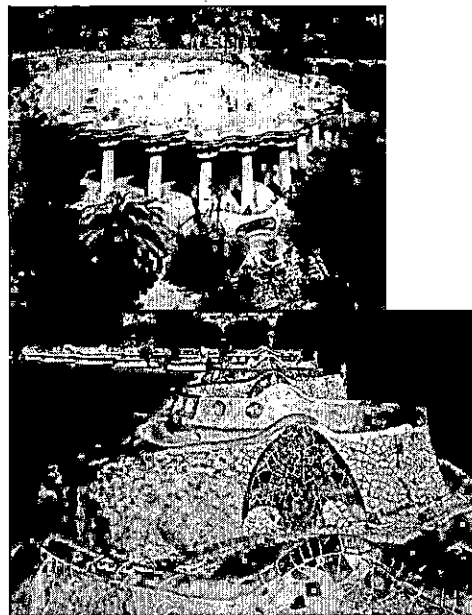

(fig35b)(3)

(fig 35c)(3)
(fig 35a) (3)

- The spiral ceiling in Casa Battlo building:

The ceiling is designed from a number of repeated and double interfaced anticlockwise horizontal golden spirals with a common center

used as the place to put light(fig36) (3).The ceiling create beauty and *arranging* energy.

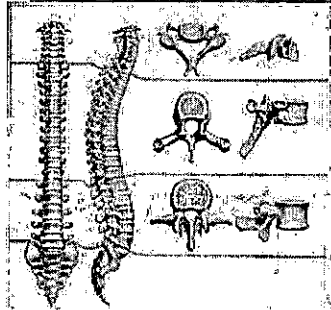
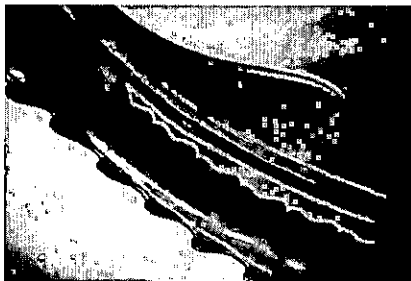

(fig37a) (3)

(fig37b) (3)

(fig 36) (3)

- Interior stair and Handless chair in Casa Battlo building :

The design of the stair has the geometric shape of a divestiture vertebral column(fig37a,b) while the design of the back and the seat and legs of the chair have ,respectively, the geometric shapes of a divestiture bones of the human being's :vertebre ,pelvis ,and legs.(fig 38 a,b,c)These sort of shape or design might be related to biosignitures shapes in reference(1).If so,they are an emitter for arranging energy.

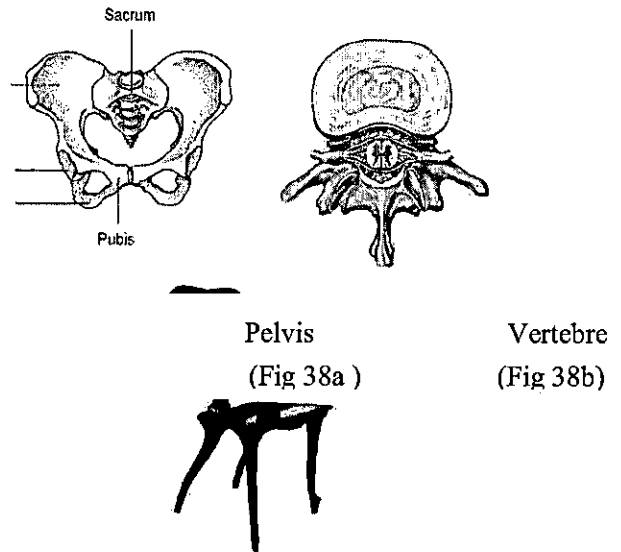

Fourth: Enhancing the role of positive energy in interior design and furniture:

1-Natural energy:

We can enhance the role of natural energy internally by:

- Making the interior environment part of the exterior environment (rivers, green areas, flowers ,birds and sun or moon light) . This can be done by putting mirrors in a studied positions opposite to the exterior openings ,hence the interior will be brighter and wider, showing more vitality and beauty.
- Transferring the exterior nature to the interior space through using:
 - Natural elements of design as material ,texture , color, shape and light.
 - Water through decorating units as fish container ,interior fountain,..etc
 - Living creatures as flowers ,shade trees,fish ,birds,...etc.

2-Openings (windows and doors)

Designing the shape of the openings:

The shapes of the openings are very important to balance the quality of the incoming energy of any type and at any level. This could be adjusted by designing the shape wide enough to be proportional with the area of the interior space

.Also the openings and its iron work must be designed according to geometric shapes which emit energy that carry horizontal negative green waves from the exterior space to interior space.

(Fig 39,a,b,c).

Three doors ,two has a rectangular shape ,the third has a corrected dome shape .The three doors emit horizontal green energy which is needed for the entrance of the home , important for charging the visitor with positive energy ,because the iron work of the door has respectively the designed shapes spiral , square and L-shape , also has the shape geometric movements :rotations , double interfaces and repetition .

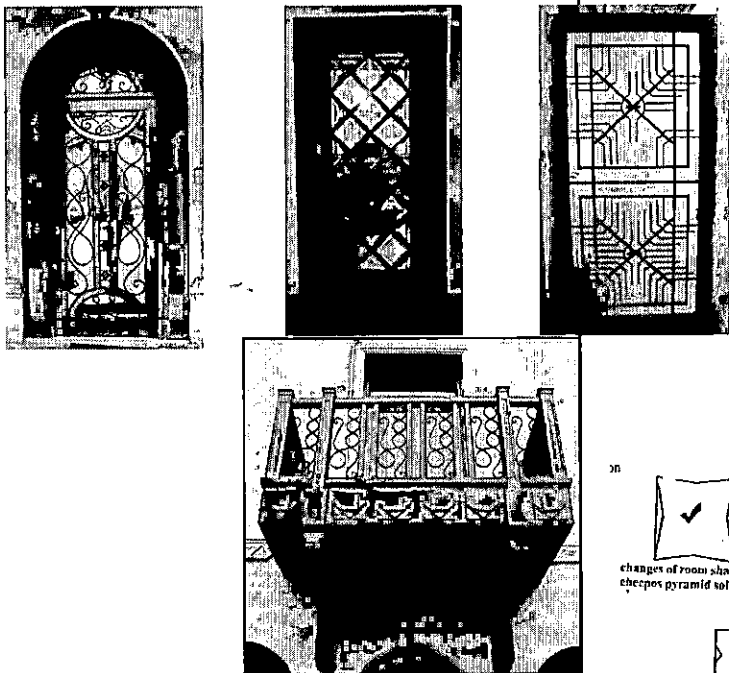

g39c) (9)

(Fig39d)

(Fig39d): The balcony lies on the top of two 90degrees L-shape kaboly. The iron work of its upper part has spiral shapes while its lower wooden part is decorated by units, each one consists of three prominent squares with a common center. These units create rotation,

repetition, and double interface movements . Hence, the balcony emits *arranging* energy.

▪ Placement of openings:

The sight where we place the openings has an important role in the flow of energy. Usually doors and windows are placed in the middle ,else it causes energy diffraction (7). Several solutions are available for the correction of off-center doors including(10): corner treatment (fig40a), square-shaped object or furniture placed diagonally(fig40b), vertical frame section outside the wall (fig40c), semi circular section outside the wall (fig40d), wall curvature (fig40e), changes of room shapes e.g pyramid solution (fig 40f), and central placement of openings (fig40m)

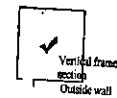

(fig39c) (9)

(fig40a) (10)

(fig40b) Square shap

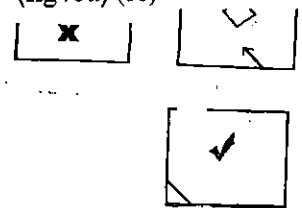

Corner treatment

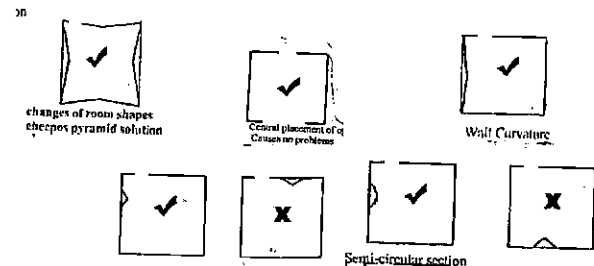

(fig40d) (10)

(fig40

3- Furniture:

▪ Designing the shape of furniture

a)To guarantee the existence of *arranging* energy in interior space we should consider the following principles in designing the shape of furniture:

- creating shape movements:rotation,double interface, repetitions and shifting
- connecting to the center of shape
- adapting the (45-90-36) degree shape , dolman shape and natural shapes.
- adapting the golden proportion and the biogeometric tools corrections.

b) using natural materials in making and finishing furniture and floors.

c) considering the role of ergonomics in designing the shape of furniture by knowing the daily effort and how long the user of the space stay.

(fig41)The mirror emits the useful horizontal negative green components by using correcting tools for the arch at the top , and using the golden rectangle shape for the mirror, also the geometric movements : repetition , rotation , double interface and shifting for small squares in the decoration.

▪ Placement of furniture :

a)The right placement of furniture is based on obtaining balance energy in interior space .Symmetric balance has equal energy on both sides of axis of symmetry while with non symmetric balance the empty space surrounding a small special shape element gives the same amount of energy like a large element with simple shape.(3)

b)The placement of furniture in interior space must permit energy flow through it because clutter in flow of positive energy causes clutter in thinking. If the interior space is narrow and crowded with furniture, then it will block energy flow ,and to avoid that , we use a few number of small sized furniture, hence there will be spaces permitting and maximizing the movement of positive energy . If the interior space is large and not full of furniture ,then there will be a maximized rush of energy flow, and to avoid that

we must fill the space with reasonable amount of furniture, to balance energy flow.(3)

c) Since direct exposure to the energy flow is harmful , then we shouldn' t place furniture opposite to openings(4) .

d) Don't place furnitures in parts of interior spaces that have negative energy such as : pointed corner , direct lighting , being under beam construction (4).

4-Designing floors,ceilings and walls:

- In designing ceilings,floors and walls, we use geometrical shapes with specific characteristics, to emit *arranging energy* in the space.

- To garantee emitting beneficial natural horizontal component of green waves we use natural materials as stone , wood or granite.

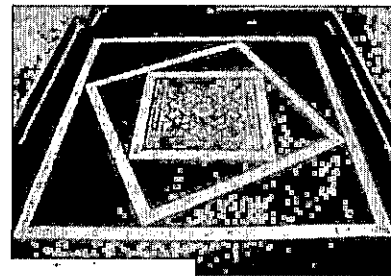

(fig41) (13)

(Fig 42a): granite floor ,designed with 90 degrees L shape with golden ratio.

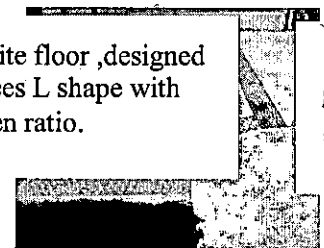

(Fig 42b): geometric m, repetition o

Disabling energy flow:

This occurs in the presence of walls ,building separators ,closed doors ,the limited spaces,wrong light placement , the heavy and crowded furniture.

Encouraging energy flow:

This occurs in the presence of roads and corridors, windows and doors , open spaces, right

light placement ,mirrors, crystals , water, and life elements(4).

Five : Application example for designing and furnishing a part of a villa in costal environment using the energy of the shape:

In this example , the interior space is divided according to the difference in function into two principle sections: living section and dinner section.

In what follows , we design and furnish the dinning and the living parts to be sources of *arranging* energy which produces space balance.(fig 43 a,b)(3)

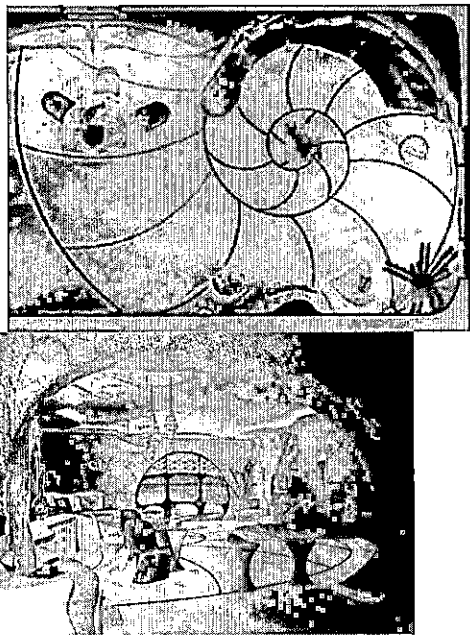

(Fig43a,b)(3) the vertical and horizontal section for designing the interior space using the golden spiral shape with rotation ,interface and repeated geometric movement, which leads to emit *arranging* positive energy to balance any negative energy.

accessories:

▪ **Placement of furniture:**

The living and dinning parts are separated from each other by an empty surrounding area. The furniture units are simple and small in size as it is a summer home ,thus permitting the energy flow.

▪ **Designing shape of furniture:**

The shapes of the furniture are geometrically divestitured from different kinds of shells and

oysters. The measurements of furniture shapes satisfy the golden ratio.

- **Dinning section :**

The stand of the dinning table is divestitured from a combination of two spiral shells (fig44a). The pinch is the horizontal shape of the shell (fig44b). The chair takes the shape of the sitting person (fig 44c). The pinch of the bar table is divestitured from the shape of the shell in(fig44d).

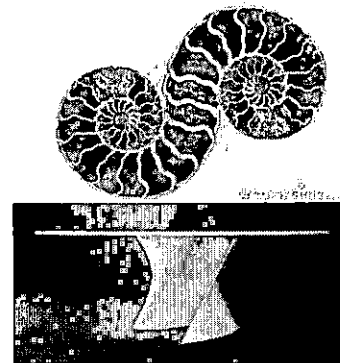

(fig44a)(3)

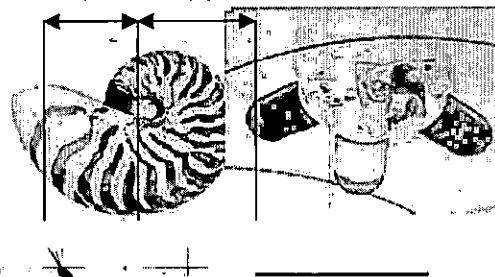

(fig44b)



(fig 44d)(3)



- Living section:

The shape of the sofa has the spiral boundary curve of a shell(fig45a),The shape of the stand of the living table is a geometric divestitured for the movement of a fish in water (fig45b). The built unit for T.V placement is the exterior shape of a shell in a vertical position (fig45c).

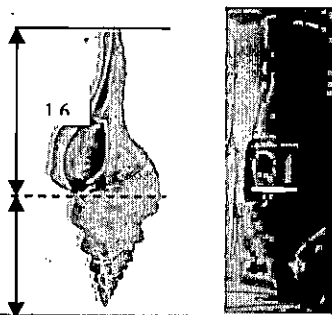

(fig45c)

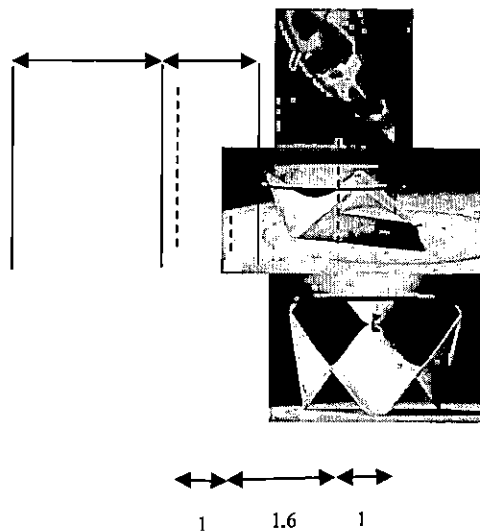
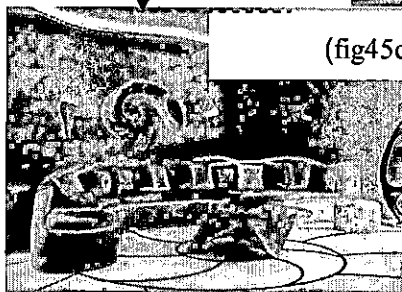

(fig45b)(3)

- Accessories:

The mirror and its frame takes the shape of two circles with a common center (fig46a).The lighting units in the ceiling ,wall and floor have the shapes of different types of shells and oysters (fig46a). The wall picture include golden spirals with contrast costal colors, blue and orange (fig45a).

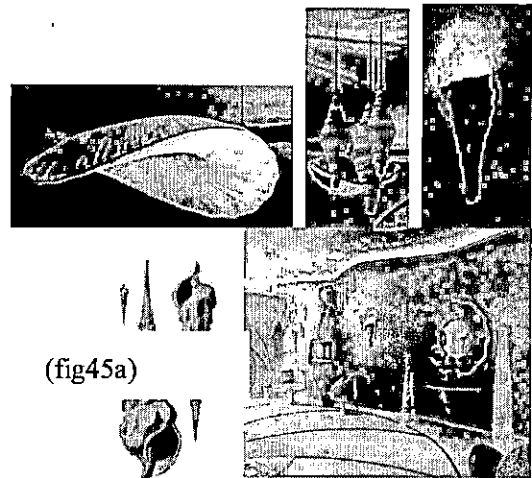

(fig45a)

(fig46a)

3-Designing the floor and ceiling:

The pattern of the floor is the spiral shape of a shell with geometric movements : repetition , double interfacing and rotation (fig47). The

ceiling is a resemblance of the shape of waves .
(fig46a)

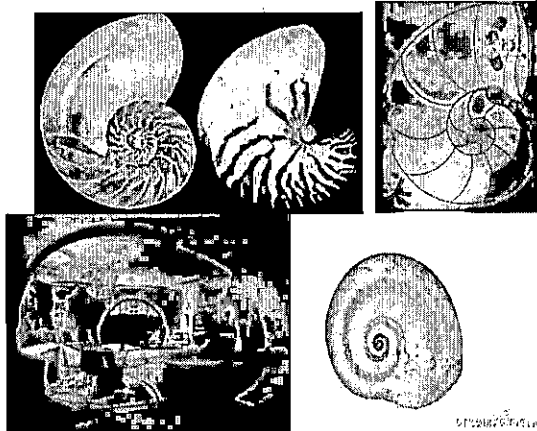

(fig47)(3)

4-The design of openings:

The design of the exterior and interior openings takes the shape of the exterior shape of the spiral of a shell (fig48).

5-Materials:

Using natural materials : stone , wood , or marble for floor, also wood and cotton for furniture.

Conclusion:

1)This study offers:

- Practical techniques to improve the quality of our life by creating positive energy in interior space , to achieve balance ,harmony ,and unity.
- A specific relationship between balanced energy and shape ,as it deals with shapes based on the golden ratio,Fibonacci and Gava numbers , also biogeometric shapes,where all bring balance to the energy fields.

- For beneficiaries: as architects ,interior designers ,furniture factories , carpenters and even non specialists who are interested in design; a beautiful , comfortable, healthy, harmonized ,balanced and tranquil living interior space.

2) The interior designer must know the proper choice of the following:

- the quality of energy needed and suitable for each function of space, location and forms.

- materials used in constructing and finishing, walls, ceilings, floors and furnitures.

- shapes of furniture, accessories, and openings, as well as their placement in the space .

- plants,water and life creatures according to their effects .

- the role of the surrounding environment in emitting positive energy.

3) To create a healthy interior space the following strategies have to be followed:

- designing for health

- reducing toxic emissions through careful choice of design elements.

- introducing the golden mean measurements during the designing process.

Recomr (fig48)(3)

1- Clarify to the local furniture producers the importance of using energy in design, by knowing the specific characteristics for design elements : shape, color ,texture ,light and material ,which emit positive energy in space.

2-Introduce to applied art students the concepts of using energy in interior design and furniture and performing special researchs to reach more progress concerning this idea.

3-Supply interior designers and furniture makers with the necessary scientific knowledge about designing with energy so that the Egyptian furniture would be distinguished from the international .

4-Cooperation between different colleges,e.g : applied arts, medicine , technology and engineering to study the effect of applying the energy concepts in the interior design and furniture in a space on the health of the inhabitants of this space.

References:

- (1) www.Ibrahim Karim, 2012 ,The science of biogeometry.
- (2) Knieger, Joachin I. ,2009 , A little Science on positive energy ,PHD.
- (3) Attia,Doaa Ismail ,2011, "The effect of natural environment on the innovation in interior

design and furniture “,PHD degree in interior design, Faculty of applied arts, Helwan university.

(4) El sawey ,Mohamed Samir, 2004,”Architecture and biogeometry”, PHD, Faculty of Engineering , Cairo university.

(5) Karim ,Ibrahim, 2010, “Back To A Future Mankind” , Cairo,Egypt.

(6)[www.biogeometry\ wat-is-biogeo-uk.html](http://www.biogeometry.wat-is-biogeo-uk.html)

(7) Karim ,Ibrahim, 2003, Lectures at losanglos .

(8)Abdel Salam Ahmed Nazef, “Studies In Islamic Architecture”, Cairo العامه للكتاب الهينه for Book, Egypt .

(9) Yousef ,Khaled mostafa ,2010, Green aritecture and design by biological energy ,PHD,Cairo University , Faculty of Engeniring.

(10) Ali, Marwa Mohamed , 2006, Biogeometry as an intergrate approach for designing Architectural living spaces,M.SC,cairo university

Internet sites

(11)www.Michael keith design.com

(12)www.Biogeometry Matter,May 2012.

(13)www.Islamic furniture.

(14)www.Islamicarch

(15)www.IslamicMashrabiya

I.